

THE MECHANICS OF HUMAN SACCADIC EYE MOVEMENT

By D. A. ROBINSON

*From the Department of Medicine, The Johns Hopkins
University School of Medicine, Baltimore, Maryland, U.S.A.*

(Received 2 April 1964)

In the investigation of oculomotor systems and especially in the mathematical descriptions of them as pursuit, tracking and stabilizing systems, the need arises for a more exact knowledge of the mechanics of the eyeball, the extraocular muscles and the supporting tissues of the orbit, particularly of the way in which these factors permit the globe to respond to the efferent discharges arising in the oculomotor nuclei. In 1954 Westheimer proposed that the eye moved in a saccade by the application of a step function of net muscular force. He further proposed that the mechanical system was of second order, slightly underdamped and had a natural resonant frequency of about 120 radians per second (19 c/s). Alpern (1962) has discussed the inadequacy of this picture in view of the large burst of activity during a saccade recorded by extraocular electromyography (Björk, 1955; Miller, 1958).

The development of the suction contact lens has made practicable a closer investigation of the mechanics of the saccade, for it provides a simple method of applying known forces and loads to the eye while measuring subsequent rotations without fear of lens slippage. The evidence presented here will demonstrate that the system of eyeball and orbital tissues is heavily overdamped, has no resonant frequency and is little affected by the mass of the eyeball. It has an upper mechanical frequency response of only 1 c/s and it succeeds in making quick saccadic movements only under the impetus of a large, briefly applied, excess force delivered by the extraocular muscles. For example, in maintaining the eye 10° horizontally from the primary position the horizontal recti need apply a net force of only 15 g but during the saccade to reach that position they apply about 43 g during the first 40 msec of movement.

METHODS

The experiments involved four procedures with the intact human eye and one with the lateral rectus of the cat. Three human, normal, adult, male subjects were used. The human experiments were conducted with normal room lighting illuminating a horizontal row of black dots spaced 5° apart on a white spherical background 1 m from the subject.

Fixation was monocular, vision being deliberately denied the test eye wearing the contact lens by black paint.

The method of measuring eye position is that of a scleral search coil in a magnetic field described elsewhere (Robinson, 1963). Briefly, the subject wears a suction scleral contact lens held to the eye by -40 mm Hg pressure in an air pocket over the cornea and carrying two coils of fine wire. The subject is then exposed to two uniform alternating magnetic fields (about 2 gauss peak, 4.8 kc/s) in phase quadrature oriented along the superior-inferior and lateral-medial axes. The coils of the lens are oriented in the sagittal and coronal planes (in the primary position of gaze) and the voltages generated in them, when appropriately processed through phase detectors, give rise to three d.c. voltages proportional to the horizontal, vertical and torsional components of gaze. One may then simultaneously record all three degrees of freedom of eye motion with a sensitivity of 15 sec of arc, an accuracy of 2% of full scale and a band width of 1000 c/s. All recordings were made on a direct-writing mirror galvanometer recorder with a band width of 2000 c/s. In this investigation, horizontal movements only were studied.

Movements of the eye will be expressed in degrees. Torques on the eye will be expressed in the force in grams with which the extraocular muscles pull at an assumed fixed moment arm of 12 mm from the centre of rotation of the globe. Thus a spring stiffness is expressed in g/deg, a viscous damping in g.sec/deg and a moment of inertia in g.sec²/deg (rather than dyn.cm.sec²/radian). All forces applied to the contact lens at a moment arm of other than 12 mm are scaled and reported as forces effectively applied (in competition with the muscles) at this moment arm. The moment of inertia of the contact lens is 0.375×10^{-4} g.sec²/deg. That of the eyeball, as a rigid body, is 0.612×10^{-4} (4.12 dyn.cm.sec²) but owing to the observation that the vitreous body is in greater part left behind during a saccade (Hilding, 1954), the functional moment of inertia is taken at about half this value, namely 0.297×10^{-4} g.sec²/deg. It will be shown subsequently that the mass of the eye has little to do with determining the time course of the saccade so that the 126% burden of the contact lens in no way distorts the results. The viscosity of the globe in the orbit is somewhat increased by eyelid friction due to the contact lens thickness (0.76 mm over the sclera, 1.3 mm over the cornea). This has not been measured, but good agreement in the saccade time course with other methods such as corneal reflexion indicates that such friction is negligible. Contact lens slippage is only of concern if it is greater than 0.5° in these experiments. With the contact lens unloaded there is no such slippage. Tangential forces on the contact lens above about 20 g result in slow creep of the lens across the sclera. For this reason only data from experiments in which the contact lens is subjected to less than 20 g shear are given credence.

Normal saccades

Eight magnitudes of horizontal saccades were studied from 5° to 40° . All saccades were roughly symmetrical about the mid line. They were recorded at a paper speed of 500 mm/sec with a time resolution of 1 msec. Three temporal and three nasal saccades were recorded at each magnitude on each subject.

Isometric saccades

A stiff beam, clamped at the base, ball shaped at the tip, was inserted into a cylindrical socket cemented to the contact lens so as to restrain the eye from moving. A coil of wire mounted on the beam served as a strain gauge to measure the force applied to the beam tip by the extraocular muscles. The beam was designed to present an apparent stiffness (to the muscles) of 60 g/deg so that a net force of 15 g from the horizontal recti which would normally rotate the eye 10° should, in the isometric case, rotate it only 0.2° . Measurement of contact-lens position revealed an actual rotation of 1° which came about by lateral deflexion of the globe in the orbit. The globe, unable to rotate on its centre, succeeds in rotating slightly about the beam tip. Thus the eye is not rendered as isometric as one might

wish and the effective isometric spring stiffness is only 15 g/deg. The moment of inertia effectively added to the eye and contact lens by the beam was 1.48×10^{-4} g.sec²/deg.

The subject's head was restrained on a bite-bar, the isometric beam applied to the left eye and the subject made normal saccadic movements with his unencumbered right eye while tension on the beam was recorded. The same fixation sequence was used as in the normal saccades.

Isotonic movements

A loop of surgical thread was tied to the socket of the contact lens and conducted temporarily to attach through an isotonic lever system to a set of weights. Despite the lever system, the sudden application of a weight produced artifacts associated with the inertia of the weight and the inability to get initial slack out of the thread. However, preliminary trials showed that the time course of movement on application of a force was simply the reverse of that on removal of the force. The step response of the eye was thus obtained by applying 5, 10 and 15 g (6.05, 12.1 and 18.15 g as seen at the moment arm of the muscles) through the lever system for 10 sec and then releasing the force suddenly (by a spring-loaded plunger) while recording the returning motion of the globe. During these manoeuvres the subject fixated in the primary position with the unencumbered eye. Three trials at each force setting were recorded for each subject.

High inertia saccades

Through the ball and socket joint the contact lens was attached to a sled carried by knife edges on a double pendulum suspension system in such a way that the sled followed the movements of the eye without offering either frictional or spring-like reacting forces. When the sled was weighted it offered only an inertial reactance to the force exerted by the horizontal recti and the mass used was such that when reflected back to a 12 mm moment arm it added an effective moment of inertia to the eyeball of 28.3×10^{-4} g.sec²/deg. This increases the moment of inertia of the eyeball by 97.5 times. With this load attached to the left eye, the subject made a series of saccades with right eye vision in multiples of 5° steps.

Isometric tension in the cat lateral rectus

Four adult cats of about 3 kg weight were anaesthetized with 30 mg/kg of pentobarbitone sodium. Their heads were secured in a stereotaxic holder. A portion of the malar bone and its frontal process was removed to facilitate the approach to the lateral rectus whose insertion was secured by surgical thread and attached to a strain gauge mounted on a manipulator. The attachment to the globe was then severed, the globe was deflated and depressed nasally. The muscle was freed of fat and connective tissue by blunt dissection to the back of the orbit in order to ensure independent mechanical action. Since the blood vessels approach and leave the muscle through the apex of the orbit, such dissection may be done without endangering the blood supply. Stimulation was accomplished by two thin platinum-wire electrodes near the two ends of the muscle, fed with voltage pulses (from a low source impedance) of 1 msec duration and varying amplitude (15–50 V) and rate (25–300 pulses/sec). Stimulation was always in the form of a brief train of impulses lasting about 1 sec. Isometric tension was transduced by a wire strain gauge, amplified and recorded by a mirror-galvanometer system with a 2 kc/s band width (–3 db). Since the extraocular muscles fatigue rapidly in tetanus a 1 min rest period was allowed between all recordings. This resulted in a stable preparation that gave reproducible results for at least 2 hr and eliminated bias from the order in which the data were taken.

Isometric muscle tension was recorded while muscle length, stimulus amplitude and stimulus rate were varied so as to enable a plot of length-tension not only in the passive and

tetanic muscle but also in the muscle when only partially stimulated by a submaximal voltage at a supramaximal rate or vice versa.

In one experiment, the cat was fixed and dissected to determine the pertinent geometry of the orbit. In another, both lateral recti were removed and their wet weights obtained.

RESULTS

Normal saccades

Figure 1 illustrates a family of typical saccades. They agree well in their course, peak velocity and time of duration with the data of Westheimer (1954) who used corneal reflexions, Yarbus (1956) who used a mirror carried on a suction contact lens and Mackensen (1958) who used the

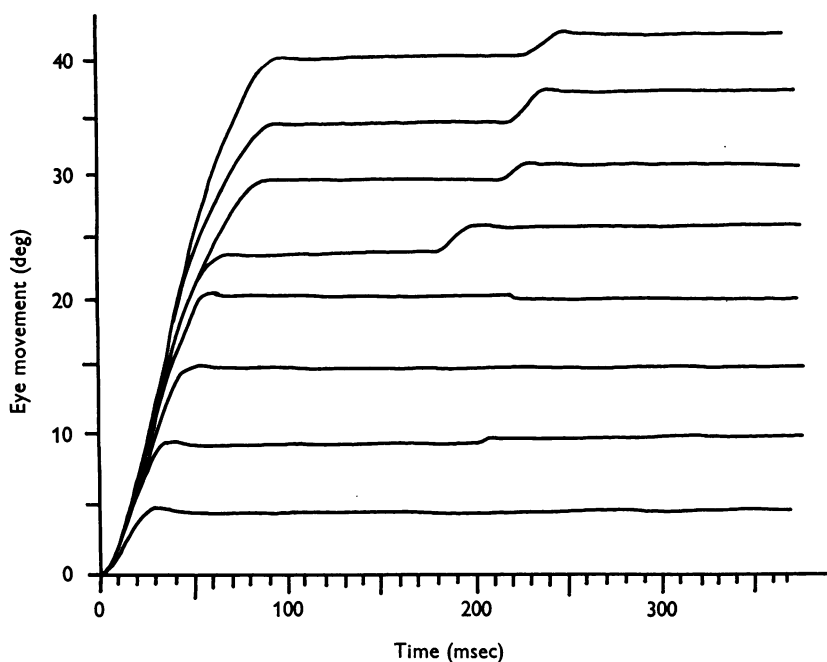

Fig. 1. Superimposed tracings of saccadic eye movements in eight steps from 5° to 40°. Records were selected from temporal saccades on one subject as representative for each magnitude.

electro-oculogram. Figure 2 illustrates the fact that in most subjects temporal saccades are executed in less time, with a higher velocity, and with more overshoot than nasal saccades. It is interesting to note in passing that this asynchrony of action can result in an instantaneous image disparity between the two eyes of as much as 2.5° as they make a conjugate 15° saccade. Figure 2 also illustrates the method used in estimating saccade duration. Figure 3 summarizes the results of saccade

durations. Nasal saccades have, on the average, durations about 5 msec longer than temporal saccades. Each group has a standard deviation of about 5 msec. Over the range 5–40 deg there is no clear trend in either the difference in duration of the two types or their standard deviations. Standard errors of the mean were typically 2% of the mean. The two

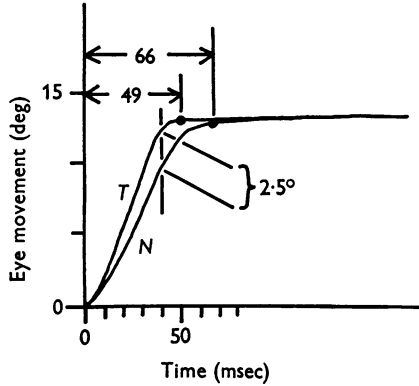

Fig. 2. Superimposed tracings of a nasal (*N*) and a temporal (*T*) saccade of the same magnitude on the same subject.

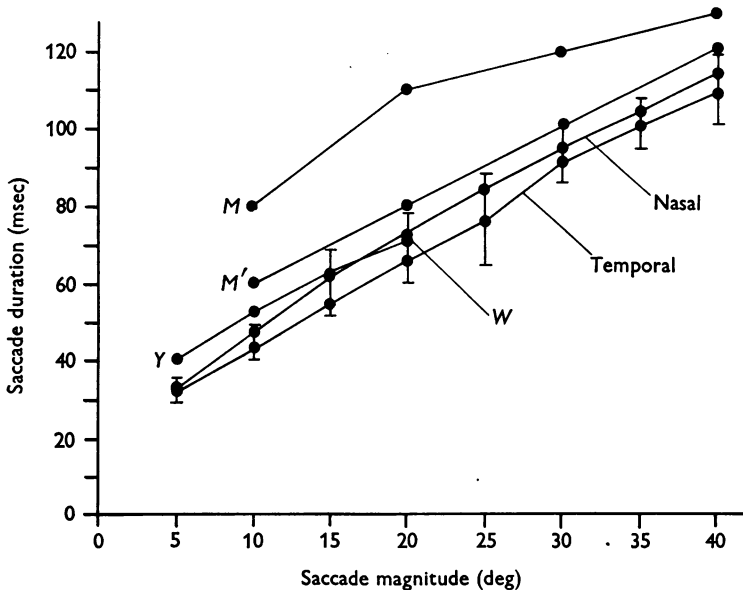

Fig. 3. Summary of saccade durations versus magnitude. Means of nine nasal and nine temporal saccades over three subjects are shown separately. Vertical bars above show the s.d. for nasal saccades, those below for temporal saccades. *W*, Datum of Westheimer (1954); *Y*, data of Yarbus (1956); *M*, data of Mackensen (1958); *M'*, data of Mackensen as re-interpreted from his own records.

distributions overlap so that it is quite possible to find individual nasal saccades with a smaller duration than individual temporal saccades even in a single recording session.

Figure 3 also indicates the results of Westheimer (1954), Yarbus (1956) and Mackensen (1958). The latter's results with the electro-oculogram, are too large but his recording system response was 3 db below its zero frequency response at 85c/s which rounds off the sharp transients and makes it difficult to distinguish the beginnings and ends of the saccades. If one re-interprets Mackensen's records in this light, the values for saccade durations fall into general agreement. It is easy to show that the response time of a linear system is independent of response magnitude so that Fig. 3 clearly indicates a non-linear system and suggests the possibility that the extraocular muscles are force limited and are unable to supply eight times the accelerating force for the 40° saccade that they do for the 5° saccade.

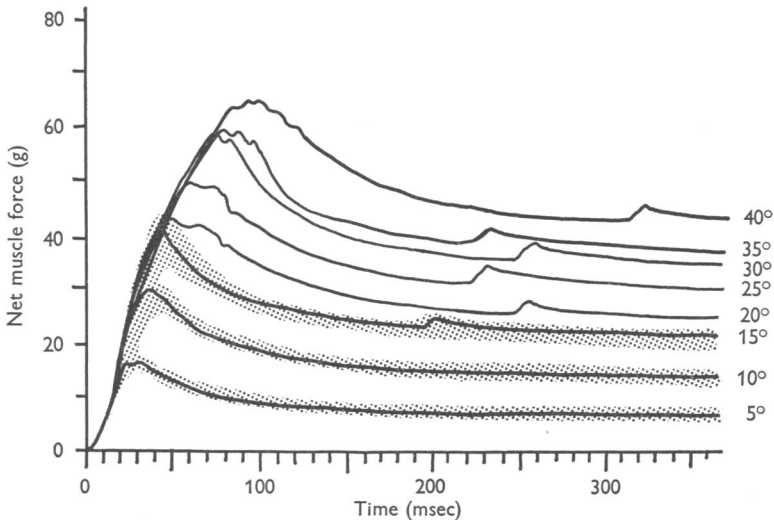

Fig. 4. Superimposed tracings of tension recorded from an isometric rod which restrains the eye from moving for various saccadic movements (5°–40°) of the free eye. Ordinate is scaled to show net muscle force at the moment arm of the radius of the eyeball (12 mm). Shading on the first three records represent the range of eighteen records over three subjects.

Isometric saccades

Figure 4 illustrates the time course of tension which the extraocular muscles apply to the isometric eye. The tension rises rapidly to a peak, then drops, quickly at first, and finally decays approximately exponentially to a steady state in about 350 msec. The mean rate of rise of tension is approximately 870 g/sec although it varies somewhat with the magnitude

of the saccade. The peak tension is reached near that instant when the eye movement (in the normal eye) is completed and is about twice the tension applied in the steady state. The time constant of the decaying phase is about 250 msec. Large saccades result in a peak of tension that occurs later in time and whose ratio to steady state tension is less than 2:1. The mean ratios of steady-state force to saccade magnitude is 1.4, 1.42 and 1.39 g/deg for 5°, 10° and 15° saccades, respectively. The shaded portions in Fig. 4 illustrate the range of the data rather than the standard deviation and illustrate good reproducibility. Above 15°, contact lens slippage can be observed in the form of slow creep. The mean steady-state force from the three lowest curves is 1.40 g/deg. Since the 'isometric' eye succeeded in rotating by 10% of volitional command, the figure 1.4 g represents the force corresponding to only 0.9° between actual position and command position. Thus the corrected figure for the tonic net horizontal recti force to maintain a given deviation of gaze is 1.54 g/deg.

Since active checking implies a brief reversal in net force or at least a drop below that required to maintain the new position, the records of Fig. 4 unequivocally deny the presence of active checking. The fact that isometric tension remains above the steady-state value for almost 200 msec after completion of the saccade indicates that the mechanical events of the orbit are by no means over when the eye comes to rest in its new position. This implies the existence of long time-constant viscoelastic elements in the orbit which will be revealed by the isotonic movements.

As in classical muscle physiology where the time course of a twitch is the reflexion of active-state tension mechanically filtered by the interaction of the force-velocity relation and the series elastic element, so the isometric tensions in Fig. 4 are filtered versions of net active-state tension which must rise much more rapidly to much higher peaks than the functions of Fig. 4. An attempt will be made to infer these active-state tensions.

Isotonic movements

That the eye does not execute a saccade on the application of a step function of force is not only suggested by Fig. 4 but confirmed by Fig. 5 which shows the rather sluggish response of the eye when a step of force is in fact applied. The motion seems to be the sum of at least two exponentials, one with a short, the other with a long time constant and is probably made up of a distribution of time constants which cannot be resolved at this degree of recording accuracy. The slow part of the time course reveals those viscoelastic elements which stress-relieve in the normal saccade at a rate just matched by the decay of net active-state tension so that the eyeball, beginning at the end of its saccade, is just held

balanced between these opposing forces. Figure 5 shows the range of three trials at each of three forces on the three subjects. The averages for the force per steady-state displacement is 1.51, 1.39 and 1.33 g/deg for the three forces 6.05, 12.1 and 18.15 g, respectively. The mean of these three numbers yields a spring stiffness for the fixating eye of 1.43 g/deg. This is to be compared to 1.54 g/deg obtained from the isometric experiments. Within the experimental error, these two numbers are considered to be the same and confirm the picture that all passive elements of the orbit

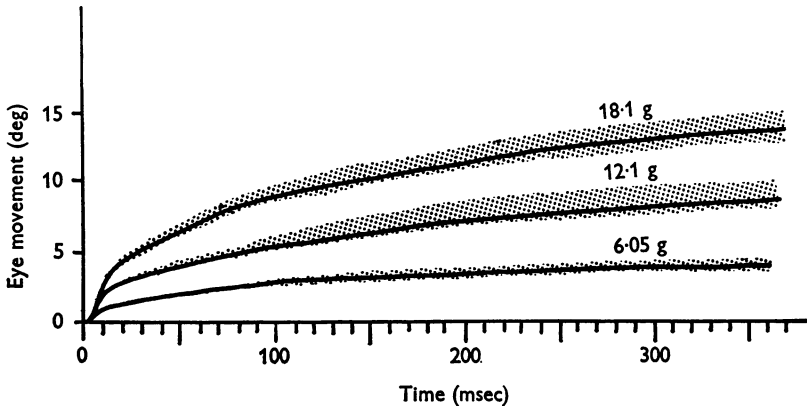

Fig. 5. Superimposed tracings of isotonic eye movement after being released from the application of the three forces shown. Shaded areas represent the range of nine records over three subjects.

(e.g. Tenon's capsule, sarcolemma, etc.) combine to offer a steady-state spring stiffness of about 1.5 g/deg and that reciprocal innervation of the horizontal recti produces 1.5 g/deg of gaze volition to offset these passive elements for the desired angle of deviation.

High inertia saccades

As one might expect, loading the eyeball with an inertia leads to the overshoot and ringing seen in Fig. 6. However, an excellent illustration of the fact that the moment of inertia of the eyeball plays a negligible role in the saccade is that an increase of the moment of inertia of 9650 % only leads to an overshoot of about 18 %. Actually this is already well illustrated in the isotonic saccades of Fig. 5 with their high initial accelerations and extremely overdamped appearance. This fact makes it possible to ignore completely the inertial loading of the contact lens during normal saccades. The primary purpose of this piece of evidence is to illustrate the subordinate nature of the mass of the eyeball but it also provides yet another time course to be encompassed by any comprehensive theory of orbital mechanics.

The cat lateral rectus

Figure 7 illustrates the rise time of isometric force in the cat lateral rectus for supramaximal stimulus near the length L_0 (that length which produces maximum added tension P_0). The rise time (to 63.2% of tetanic

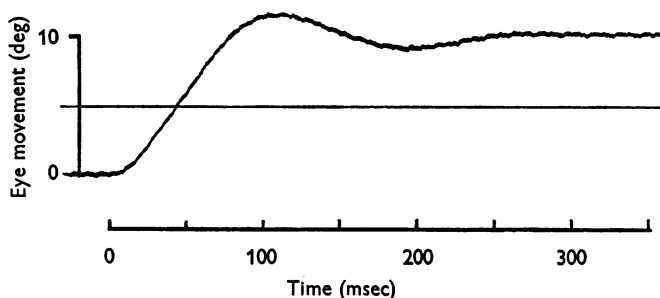

Fig. 6. Typical record of saccadic eye movement when the eye is burdened by 97.5 times its normal moment of inertia.

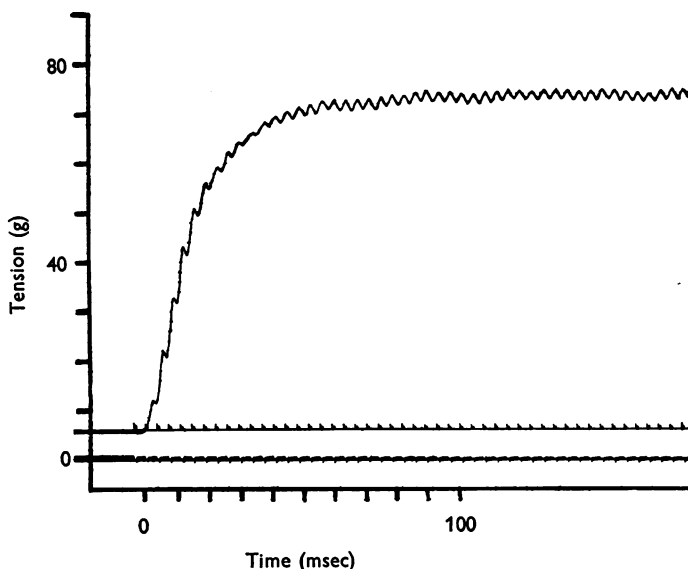

Fig. 7. The rise of isometric tension in the cat lateral rectus. Stimulus rate, 250 pulses/sec. While fusion is not complete, the rise time of tension was unaffected by stimulus rate from 100 pulses/sec to 300 pulses/sec.

tension) is 20 msec which is in agreement with the data of Cooper & Eccles (1930). Almost no variation in rise time was found with stimulus rate, muscle length or among the four muscles tested. If the series elastic element and force-velocity components of muscle were approximated by

straight lines of slope K_e g/mm and R_m g.sec/mm, respectively, the rise of isometric tension would be truly exponential with a time constant T_m given by $T_m = R_m/K_e$. The time constant of 20 msec in cat lateral rectus will be subsequently used to estimate R_m and K_e for human extraocular muscles.

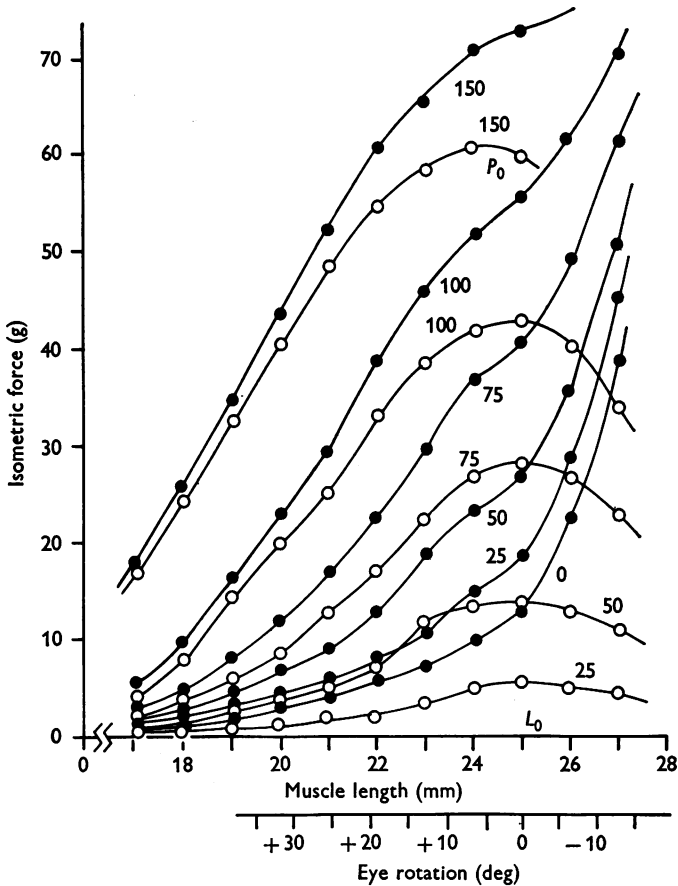

Fig. 8. Isometric length-tension diagrams of the cat lateral rectus showing total tension (●) and added tension (○). Numbers refer to stimulus rate in pulses per second. Voltage was supramaximal. L_0 is assumed to coincide with 25 mm, the *in vivo* length of the lateral rectus in the primary position. Eye rotation was calculated with 9 mm as the eyeball radius.

Figure 8 shows the length-tension diagram of the cat lateral rectus. The four muscles tested all gave similar results only differing in P_0 which ranged from 30 to 60 g. Unfortunately only changes in muscle length are known from the manipulator. Absolute muscle length was unknown although subsequent dissection of the undisturbed orbit revealed the cat

lateral rectus to be 25 mm in length (tendon excluded) in the primary position. It must be stressed that it is only an assumption (although physiologically reasonable on the basis of function) that L_0 coincides with the length of the lateral rectus in the primary position as shown by the abscissa in Fig. 8. Since the radius of the posterior portion of the cat's globe is 9 mm, it is also possible to calibrate the abscissa of Fig. 8 in degrees of horizontal gaze. Supramaximal voltage was used at various stimulus rates. Almost identical results are achieved at a supramaximal rate at various stimulus strengths. For the muscle in Fig. 8, 150 pulses/sec was maximal, fusion was almost complete and increasing the stimulus rate to 300 pulses/sec resulted in no increase in tension. At lower stimulus rates, mean tension is the value plotted. In what follows a distinction is drawn between passive tension and added tension which is total tension minus passive tension. The muscle is conceptually divided into two parallel elements, one of which exerts passive tension alone, the other added tension alone. Since the extraocular muscles are probably never in a passive or tetanic state in normal vision, it is important to know their length-tension diagrams in a state of tone at various levels of innervation. This is approximated (rather crudely) by varying the stimulus rate. The important feature of Fig. 8 is that the length-added tension curves are similar in shape and centring (except that for 150 pulses/sec, whose peak occurs at a lower muscle length) and differ from each other principally by only a scale factor. While this is intuitively what one might expect, it is a fact not well represented in the literature and thus in need of experimental verification.

The steady-state mechanics of horizontal gaze in the cat may now be summarized in Fig. 9. Assume the lateral and medial recti to have identical length-tension curves. The medial rectus passive tension is replotted from Fig. 8 (*mr*) using angle of gaze for the abscissa. Lateral rectus passive tension (*lr*) is plotted backwards and upside down (since it is an antagonist). Net passive tension is their sum and has a slope of 2 g/deg. It is assumed that tone in both recti results in a curve as that for a stimulus rate of 50 pulses/sec in Fig. 8. This curve is replotted for each muscle (*mr* 50 and *lr* 50) in Fig. 9. Their sum is net added tension (net 50). It is equal and opposite to net passive tension at point *P*, the primary position. The curves (*mr* 75 and *lr* 25) are replotted from Fig. 8 on the assumption that the medial rectus, as agonist, rises in tone to a curve comparable with that for 75 pulses/sec and the lateral rectus as antagonist drops in tone comparable with that for 25 pulses/sec. The sum of these two curves (net 75-25) is the net force that impels the eye nasally until it is balanced at *Q* by the net passive force. This results in a nasal gaze of 6.5° under a net added force of 13 g.

While the above is not a numerically correct description of eye movements in the intact cat orbit, nevertheless, it is close enough to the picture seen in the human orbit to give support to the notion that most of the orbital spring stiffness resides in the passive components of the muscles and suggests that the picture is qualitatively correct and applicable to the

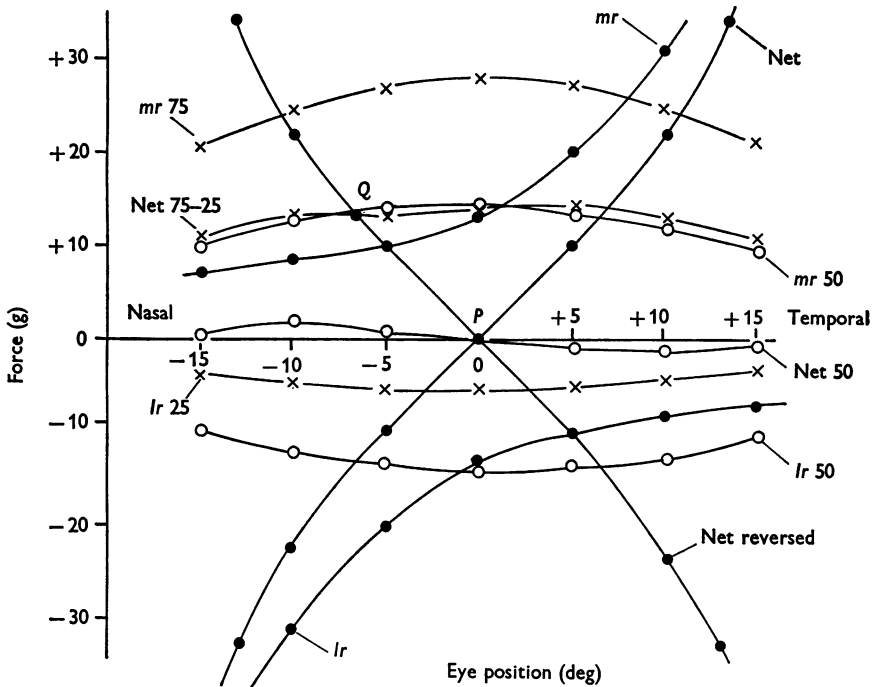

Fig. 9. A composite length-tension diagram for both horizontal recti in the cat based on the data of Fig. 8. Eye movement is positive temporally and forces are positive when directed nasally. Passive tensions (●) are shown for the medial rectus (*mr*) and lateral rectus (*lr*) and their sum, net passive tension. Added tensions (○) for an assumed tonic discharge rate of 50 pulses/sec are shown for *mr*, *lr* and their sum, net added tension. Added tensions (×) are shown with *mr* as agonist (75 pulses/sec) and *lr* as antagonist (25 pulses/sec) resulting in a net added force (75-25) which holds the eye 6.5° nasally under a force of 13 g.

human orbit. Most important, it implies that net added tension is relatively independent of eye position and, at least for small movements, may be assumed to be independent.

It is of some use to measure the stress in g/cm^2 of mammalian extraocular muscle. Two lateral recti from the same cat weighing 140 and 160 mg exerted a maximum added isometric tension of 38.1 and 42.5 g, respectively. Estimating stress by force times length (2.5 cm) divided by volume (weight), the average peak stress of the two muscles is 670 g/cm^2 .

This is somewhat lower than the 1–2 kg/cm² usually found for skeletal muscle and the reason for this is not clear. The wet weight of human extraocular muscles, secured at autopsy, (67-year-old, 67 kg male) were: lateral rectus, 0.89 g; medial rectus, 0.97 g; superior rectus, 0.76 g; inferior rectus, 0.837 g. With primary-position muscle lengths of 40.8, 40.6, 41.8 and 40 mm, respectively, (Volkman, 1869), and the stress from cat muscle, the peak isometric tensions of these human muscles are estimated at 146, 158, 122 and 140 g, respectively.

DISCUSSION

The most appropriate discussion is in the form of a theory which accounts at once for all the reported observations. Such a theory is without merit if its predictions are not quantitatively accurate so the schema must be represented by a system of differential equations which may easily be solved electrically on an analogue computer. The schema is shown diagrammatically in Fig. 10. The globe is a mass of moment of inertia m on which three forces may act, F_a the force applied externally on the contact lens during the isotonic experiments, F_m the force exerted by the net added tension of the horizontal recti and F_p the net restraining force of all passive tissues in the orbit. Many of the latter are non-contractile elements of the muscle itself such as the sarcolemma, sarcoplasmic reticulum, perimysium, endomysium and the vasculature, the remaining passive tissues including Tenon's capsule, orbital fat, conjunctival tissue, check and suspensory ligaments. From the double time-constant nature of the isotonic movements the passive elements are most simply represented by two viscoelastic elements called Voigt elements. The use of Voigt elements in analysing the rheology of tissue has been discussed by Buchthal & Kaiser (1951). One element is given a small time constant, the other a large time constant as suggested by Fig. 5. During the isometric experiments, this passive structure has placed in parallel with it a spring of stiffness K_i (15 g/deg) to represent the isometric beam. The moment of inertia of the eyeball may be artificially changes as indicated in Fig. 10 to simulate the isometric and high inertia saccades. Net added muscle force F_m is a reflexion of net added active-state tension F_0 and equals it in the steady state. A review of the dynamic relation between tension and active-state tension and the effects of the series elastic element and the force-velocity relation has been given by Wilkie (1956). If one permits a linear approximation of the force-velocity relation and the stress-strain curve of the series elastic element, the schema of a muscle is a dashpot of viscous damping coefficient R_m g.sec/deg and a spring of stiffness K_e g/deg as shown in Fig. 10. The evaluation of K_e and R_m is made as

follows. Although the stretch of the series elastic element in percent of L_0 under peak tension P_0 has been found to lie between and 2 and 10% most determinations have been in frog muscle. Wilkie (1950) in human muscle found 10%. On the assumption that P_0 for the human lateral rectus is 150 g and noting that 10% of L_0 (40.8 mm) is 18° of eye rotation, K_e becomes 8.4 g/deg. Assuming the rise time of cat and human extraocular muscles to be

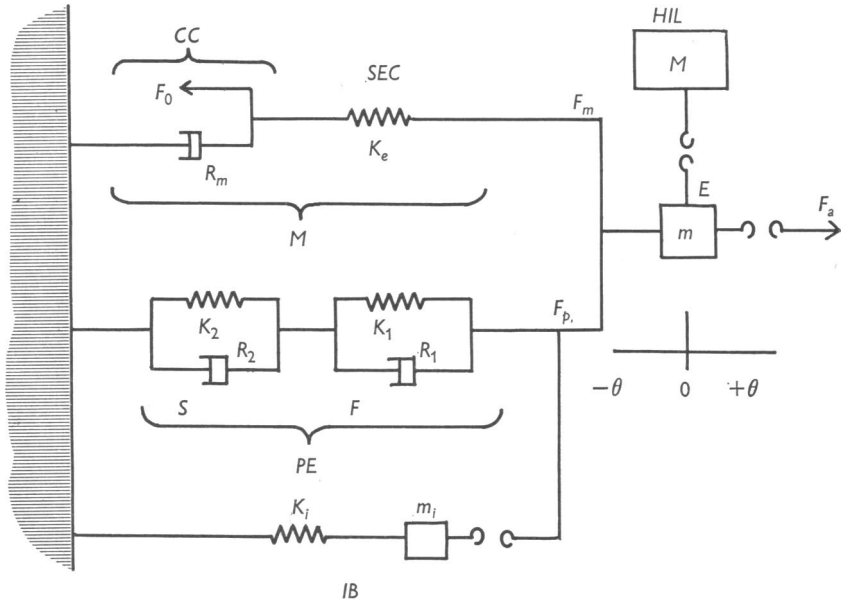

Fig. 10. The simplest schema of the mechanical elements of the orbit yielding calculated results in agreement with experimental results. The active portion of the muscle (M) is divided into a contractile component (CC) and a series elastic component (SEC). All passive elements of the orbit and muscles (PE) are grouped into a slow (S) and fast (F) viscoelastic element. Experimental procedures with the isometric beam (IB), high inertia load (HIL) and isotonic forces (F_a) are indicated. Moments of inertia m , spring stiffnesses K and viscous resistances R are given in Table 1 for the human orbit.

the same (0.02 sec) then $R_m = 0.02 K_e$ or 0.168 g.sec/deg. However, these values are representative of the tetanized muscle. They are much less in the muscle under modest tone. Evaluation of the decrease was accomplished on the analogue computer by iterative trials which finally gave behaviour compatible with experimental results. The final values used were 1.8 g/deg and 0.036 g.sec/deg in a single muscle or 3.6 g/deg and 0.072 g.sec/deg for both muscles for K_e and R_m , respectively.

The equations for the schema are as follows. Summing all forces on the globe yields

$$m \frac{d^2\theta}{dt^2} + F_p = F_m + F_a. \quad (1)$$

The equation for the way in which net added muscle force F_m is related to net active state tension F_0 is

$$\frac{R_m}{K_e} \frac{dF_m}{dt} + F_m = F_0 - R_m \frac{d\theta}{dt}. \quad (2)$$

The two Voigt elements offer a passive force F_p related to eye movement θ by

$$R_1 R_2 \frac{d^2\theta}{dt^2} + (R_1 K_2 + R_2 K_1) \frac{d\theta}{dt} + K_1 K_2 \theta = (K_1 + K_2) F_p + (R_1 + R_2) \frac{dF_p}{dt}. \quad (3)$$

Equations (1), (2) and (3) when combined result in a fourth-order linear-differential equation which describes eye movement θ in response to forces F_a externally applied or neural commands *via* active state tension F_0 . The parameters R_1 , K_1 , R_2 and K_2 are found by iterative approximations that yield the best match with experimental data. Table 1 summarizes all coefficients used in the final schema.

TABLE 1

Parameter	Symbol	Value
Net muscle series elastic stiffness	K_e	3.6 g/deg
Net muscle force-velocity slope	R_m	0.072 g. sec/deg
Muscle time constant	T_m	0.02 sec
Fast passive viscoelastic elements	{ Spring stiffness	K_1 2.06 g/deg
	{ Viscosity	R_1 0.025 g. sec/deg
	{ Time constant	T_1 0.012 sec
Slow passive viscoelastic elements	{ Spring stiffness	K_2 6.36 g/deg
	{ Viscosity	R_2 1.81 g. sec/deg
	{ Time constant	T_2 0.285 sec
Combined passive spring stiffness	$\frac{K_1 K_2}{K_1 + K_2}$	1.5 g/deg
Isometric beam stiffness	K_i	15.0 g/deg
Moments of inertia	{ eye and lens	m 0.677×10^{-4} g. sec ² /deg
	{ with isometric beam	$m + m_i$ 2.16×10^{-4} g. sec ² /deg
	{ with sled load	$m + M$ 28.9×10^{-4} g. sec ² /deg

Figure 11A and B compares the experimental results with the results of the theory embodied in the schema of Fig. 10. In Fig. 11B is also shown what can never be measured in practice, the net active-state tension needed to drive the eye saccadically. It is in the form of a burst of activity (clearly seen in the electromyogram) resulting in a rapid increase in active-state tension (to 43.4 g for the 10° saccade) which abruptly ceases a few milliseconds before the globe reaches its new position but retains a tail that slowly decays to the new tonic level. While a better match of the experimental model might be obtained by assuming a more complicated theory, the schema of Fig. 10 has the advantage of being the simplest system consistent with known physiology of the mechanics of muscle and

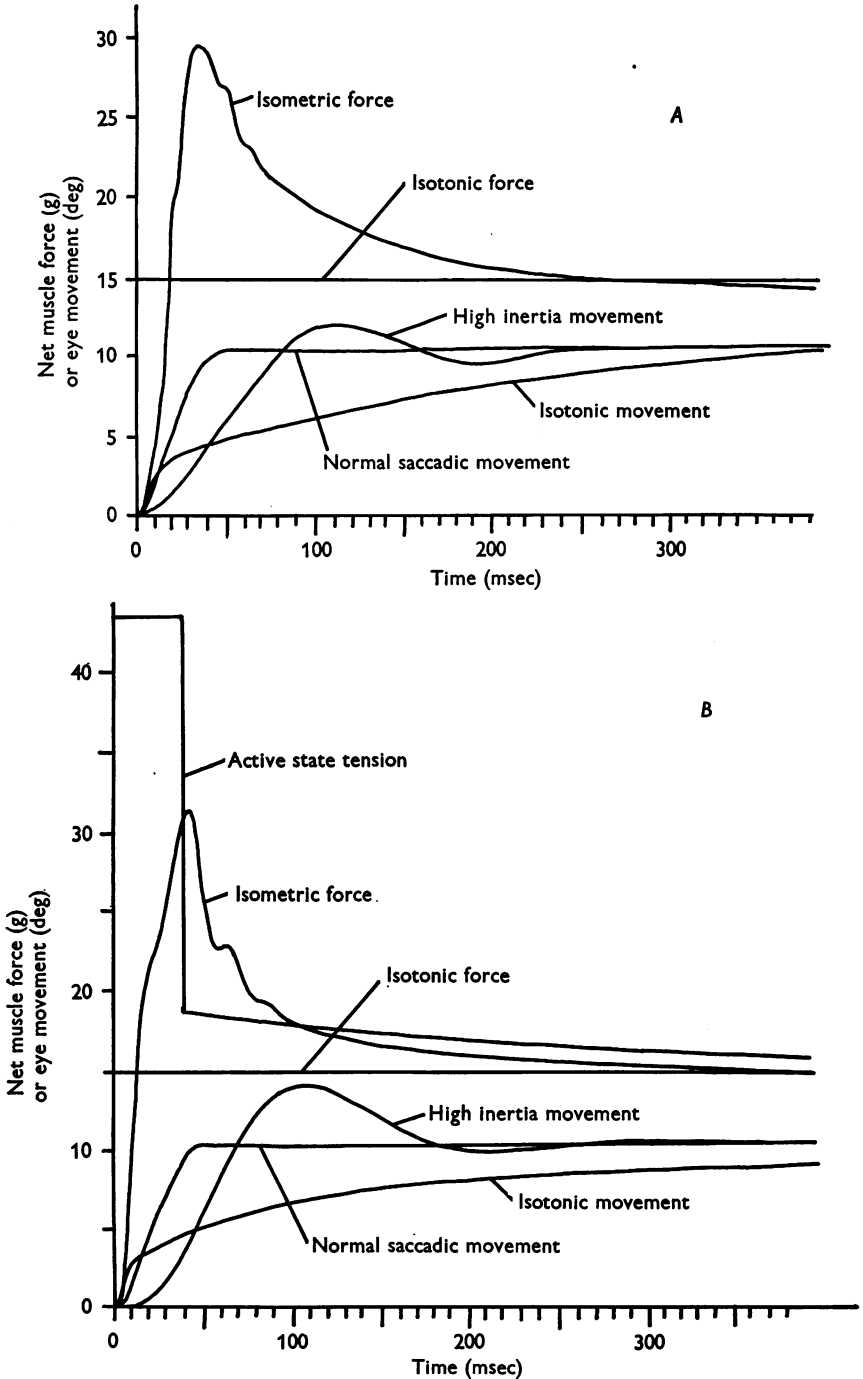

Fig. 11. *A*, The time courses of the isometric, isotonic, high inertia and normal experiments for the 10° saccade super-imposed. *B*, The same time courses calculated by the theory represented schematically in Fig. 10.

passive tissue that agrees quantitatively as well as qualitatively with the results of all four experimental procedures on the human eye. Other combinations of the physical constants R_m , K_e , R_1 , R_2 , K_1 and K_2 (none of which can be changed without altering all four time courses) result in a poorer over-all fit to the data indicating very little indeterminacy in their empirical evaluation. The theory embodied in Fig. 10 and equations (1), (2) and (3) is thus tentatively submitted as the simplest consistent with the known facts.

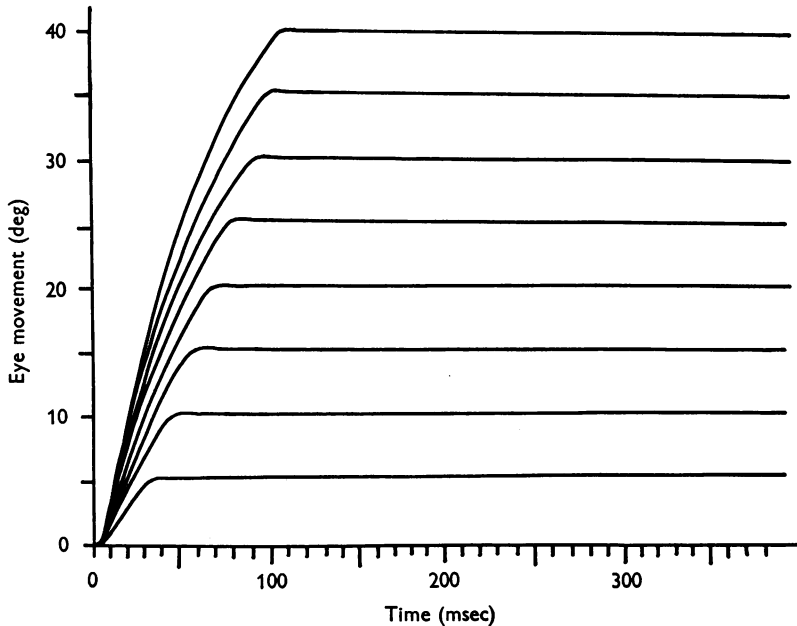

Fig. 12. Calculated saccadic eye motions from the schema of Fig. 10. The strength and duration of the excess net added active state tension were varied in each curve as shown in Table 2 until saccade duration matched the experimental values of Fig. 3.

Having determined the optimum tissue impedance for the 10° saccade one may now investigate the saccades of other magnitudes. The active-state tension in Fig. 11B has three components, a tonic component of 15 g, a slow decay component of 3.9 g (which just offsets stress relaxation in the slow tissue elements) and a briefly applied excess component of 24.6 g. If the orbital impedance is assumed linear within 20° of the primary position then every increase in gaze deviation must be taken with a proportional increase in the tonic and slow decay components. This is necessary to keep the eye steady in its new position commencing just at the completion of the saccade. However, it is clear from the isometric experiments as well as electromyography that the excess force does not rise

proportionally (otherwise all saccades would be accomplished in the same time interval) but rises more slowly and is applied for longer periods of time. Thus a trade is made in strength at the expense of duration. This notion was applied to the schema by finding that strength and duration needed for the excess force to accomplish each saccade in the time measured experimentally (Fig. 3). The resulting family of saccades is shown in Fig. 12 which may be compared directly with Fig. 1. The schedule of excess force strength and duration is shown in Table 2.

TABLE 2

Saccade magnitude (deg)	5	10	15	20	25	30	35	40
Excess force	{ Strength (g)	20	24.6	26	25.2	25.2	23	22
	{ Duration (msec)	29	40	55	65	74	87	100

The interesting feature of Table 2 is the remarkable constancy of the strength of the excess force. It is highly suggestive of a functionally separate group of motor units which act in an all-or-none fashion and are called upon only when the eye is to make a saccade. Being unable to supply more or less than about 25 g, these units can only vary their response to different saccade magnitudes by variation of their duration of activity. Possibly such speculation can be confirmed by the electro-myogram. At least the responses of Fig. 12 in conjunction with Table 2 do confirm the notion that larger saccades take a longer time because the available force during the period of motion is somehow limited in its magnitude.

The question arises, what is the mechanical band width or frequency response of the eyeball? Westheimer in likening it to a second-order system with a damping factor of 0.7 reported a band width of 120 rad/sec (19.1 c/s) in 1954 and 240 rad/sec (38.2 c/s) in 1958 for the 20° saccade. Unfortunately the method of estimating was not reported. Since the 20° saccade has a duration (to the peak of its first overshoot) of 69 msec and this point is reached by such a system when $\omega_0 t = 4.0$, this yields yet another value for the band width ω_0 , namely 58 rad/sec (9.2 c/s). These inconsistencies are good evidence that the time course of a saccade is not in fact the step response of a second-order system. The latter estimate, although considerably less than Westheimer's, is a more reasonable one because it agrees with well-established data on saccade durations. Because saccade duration varies with magnitude, this analysis indicates a range of apparent band widths from 19.1 c/s for the 5° saccade to as low as 5.7 c/s for the 40° saccade.

It is possible to seek the band width of the system in Fig. 10 to a sinusoidally applied active state tension F_0 . The result (-3 db) is 1.1 c/s which is the correct answer to the original question. The reason that a

system with such a poor frequency response can execute so rapid a saccade is due entirely to the excess force. This is known in automatic control theory as frequency compensation and this particular type will here be called pre-emphasis. Thus, owing entirely to pre-emphasis occurring centrally to shape the neural discharge pattern, the sluggish system of the orbit is driven to make the rapid movements that cause it to appear to have a band width between 6 and 20 c/s depending on the saccade magnitude. An important question raised by this is whether the pre-emphasis effect is reserved for the saccade alone or whether it plays a role in the smooth pursuit type of eye movements.

It should finally be noted that none of the experiments reported here shed light on the presence or absence of a myotatic reflex mediated by the stretch receptors of the extraocular muscles. If one analyses the hypothetical effect of net excitation (and inhibition) from stretch receptors in an antagonistic muscle pair on the net tension of that pair it becomes apparent that these afferent impulses, whether tonic or phasic, express themselves mechanically as an apparent alteration of the spring stiffness and viscosity of the orbital contents. So long as these neural reactions do not change from one type of experiment to another (as by alteration in the discharge of efferents to the stretch receptors) or are not grossly non-linear in their net effect, it is impossible to distinguish in the intact orbit whether the passive elements (*PE*) in Fig. 10 are truly physical passive elements or are, in part, only expressions of a myotatic reflex. Such an ambiguity can only be resolved by a violation of the orbit, either surgical or pharmacological, which can isolate and alter individual elements.

SUMMARY

1. Four types of saccadic eye movements, normal, isometric, isotonic and high inertia, were studied in the human eye. Speed of response and isometric length tension diagrams were recorded in the cat lateral rectus. These data were fitted together to form a mechanical schema of the human orbit that agrees quantitatively and qualitatively with the observed findings.

2. The eye is impulsively driven in a saccade by a brief burst of force much larger than that needed to hold the eye in its new position.

3. The force applied tonically to deviate the eye against the restraining orbital tissues is 1.5 g/deg.

4. The excess active state tension briefly applied during a saccade is estimated at 25 g and is independent of saccade magnitude.

5. The mass of the eyeball plays a negligible role in determining the time course of the saccade.

6. There is no active checking. The eyeball is decelerated by the highly viscous nature of the orbital supporting structures.

7. The fact that the duration of a saccade increases with its magnitude can be accounted for by limitation of the excess force applied during the saccade.

8. The mechanical events in the muscles and orbital tissues are not complete until about 250 msec after the completion of the saccade.

9. The frequency at which the mechanical response of the eye and its attachments is 3 db below that at zero frequency is 1.1 c/s.

10. Pre-emphasis of the neural discharge pattern to the extraocular muscles by central mechanisms causes saccadic eye movements to have an apparent band width (-3 db) of from 6 c/s for large saccades to 20 c/s for small saccades.

These studies were supported by PHS Research Grant AM-05524 from the National Institute of Arthritis and Metabolic Diseases, U.S. Public Health Service. The author wishes to thank Dr R. Bergman of the Department of Anatomy of The Johns Hopkins University for his aid and counsel in the experiments on the cat lateral rectus and Dr C. F. Hazlewood and Mr W. J. Sullivan for participating as subjects in the experiments.

REFERENCES

- ALPERN, M. (1962). The extra-ocular muscles. In *The Eye*, Vol. 3, p. 159, ed. DAVSON H. London: Academic Press.
- BjÖRK, A. (1955). The electromyogram of the extraocular muscles in optokinetic nystagmus and in reading. *Acta Ophthalm., Kbh.* **33**, 437-454.
- BUCHTHAL, F. & KAISER, E. (1951). The rheology of the cross striated muscle fibre. *Biol. Medd. Kbh.* **21**, No. 7.
- COOPER, S. & ECCLES, J. C. (1930). The isometric response of mammalian muscles. *J. Physiol.* **69**, 377-385.
- HILDING, A. C. (1954). Normal vitreous, its attachments and dynamics during ocular movement. *A.M.A. Arch. Ophthalm.* **52**, 497-514.
- MACKENSEN, G. (1958). Die Geschwindigkeit horizontaler Blickbewegungen. *Graefes Arch. für Ophthalm.* **160**, 47-64.
- MILLER, J. E. (1958). Electromyographic pattern of saccadic eye movements. *Amer. J. Ophthalm.* **46** (No. 5, Pt. 2), 183-186.
- ROBINSON, D. A. (1963). A method of measuring eye movement using a scleral search coil in a magnetic field. *Institute of Electrical and Electronics Engineers, Transactions on Bio-Medical Electronics BME-10*, 137-145.
- VOLKMAN, A. W. (1869). Zur Mechanik der Augenmuskeln. *Ber. Sächs. Ges. (Akad.) Wiss.* **21**, 28-69.
- WESTHEIMER, G. (1954). Mechanism of saccadic eye movements. *A.M.A. Arch. Ophthalm.* **52**, 710-724.
- WESTHEIMER, G. (1958). A note on the response characteristics of the extraocular muscle system. *Bull. Math. Biophys.* **20**, 149-153.
- WILKIE, D. R. (1950). The relation between force and velocity in human muscle. *J. Physiol.* **110**, 249-280.
- WILKIE, D. R. (1956). The mechanical properties of muscle. *Brit. med. Bull.* **12**, 177-182.
- YARBUS, A. L. (1956). The motion of the eye in the process of changing points of fixation. *Biofizika*, **1**, 76-78.